

WORKING
TOGETHER
FOR
BETTER

WORK
LOCAL
THINK

GROUP

TOMORROW

GLOBAL

R & T

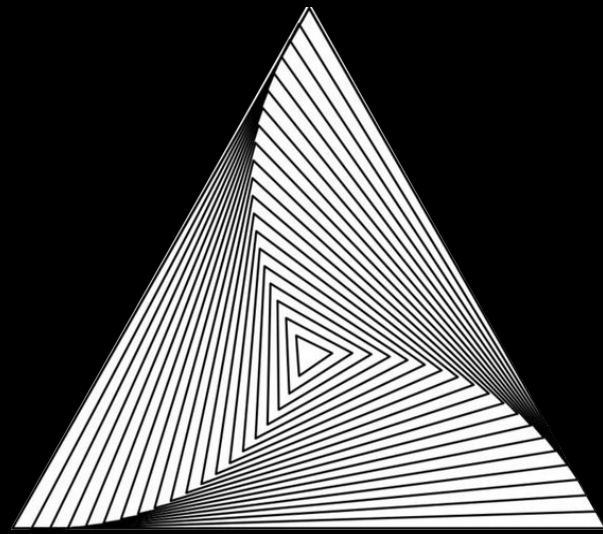
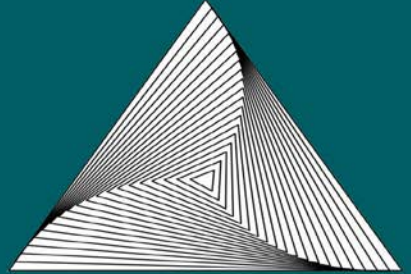

WORKING LOCAL THINK GLOBAL

WORKING
TOGETHER
FOR
BETTER
TOMORROW
GLOBAL
R & T
WORK
LOCAL
THINK
GROUP

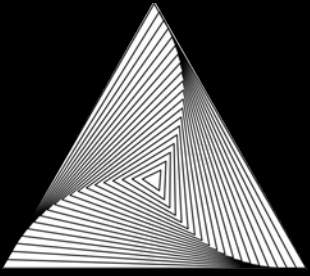

BACKGROUND TO

- R&T is established in 1995
- Principal country of activity: Albania
- More than 100 contracts completed
- R&T is one of the largest companies in Albania
- Further international expansion planned for our construction business 2019/20 Current Position
- 240 employees

- Regularly ranked as a top performing business in Albania
- Awarded ISO 9001:2015 in October 2005
- Awarded ISO 14001:2015 in April 2008
- Awarded ISO 27001:2013 in February 2011
- Awarded BS OHSAS 45001:2018 in July 2011
- Awarded ISO 39001:2012 in October 2014
- Awarded EN ISO 3834-2:2006 in September 2016
- Awarded SA 8000:2014 in January 2017
- Awarded ISO 50001:2011 in March 2015
- Awarded PASS 99:2012 in October 2015
- Awarded ISO 20000-1:2011 in August 2018
- Awarded ISO 22301:2012 in August 2018
- Ambition: To be number one in Albania / Balkan Region

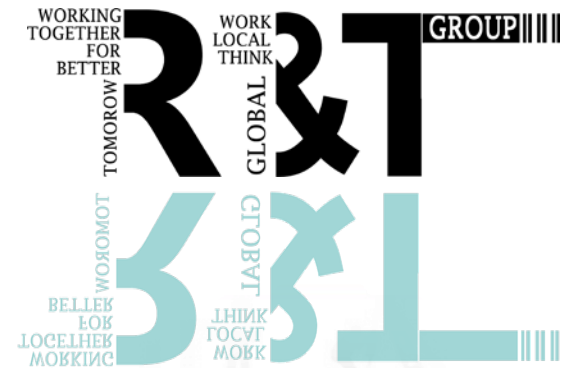

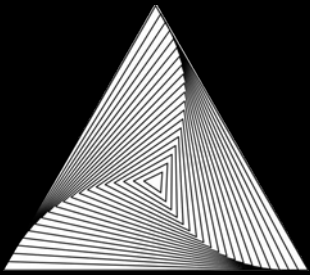

BACKGROUND TO

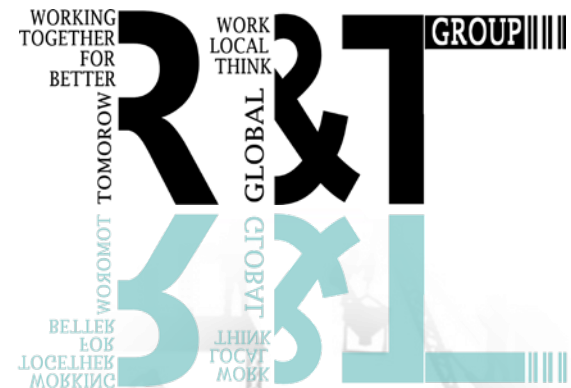

CERTIFIKATË

European Quality and Safety Control (EQSC)

lëshon këtë certifikatë për

R & T Sh.p.k.
Rr: Luigj Gurakuqi, P. 89, Sh. A
1001 Tiranë, Shqipëri



Duke konfirmuar zhvillimin dhe zbatimin efektiv të
**SISTEMIT TË MENAXHIMIT TË
VAZHDIMËSISË SË BIZNESIT**

Në përputhje me kërkesat e standardit:
ISO 22301:2012

Për fushën e aktivitetit:
Tregti, Inxhinieri Civile dhe Restaurim

EAC: 28, 29



CS 004 24.11.2014
CS 010 04.12.2018

EP130_2 Versiun 5
Efektive date: 16/11/2016

Numeri i certifikatës: 0117
Data e Certifikimit Fillëtar: 09/08/2018
Data e lëshimit: 06/12/2018
E vlefshme deri më: 08/08/2021
Numeri i Rishtimit: 1



European Quality & Safety Control (EQSC): Selisjuan Pasha, Pallati 70/1, Kat 1, Nr.1, 1016 Tiranë, Shqipëri | Tel: +355 4 222 7074, E-mail: info@eqsc-cert.com, www.eqsc-cert.com



CERTIFIKATË

European Quality and Safety Control (EQSC)

lëshon këtë certifikatë për

R & T Sh.p.k.
Rr: Luigj Gurakuqi, P. 89, Sh. A
1001 Tiranë, Shqipëri



Duke konfirmuar zhvillimin dhe zbatimin efektiv të
**SISTEMIT TË MENAXHIMIT TË
SIGURISË SË INFORMACIONIT**

Në përputhje me kërkesat e standardit:
ISO 27001:2013

Për fushën e aktivitetit:
Tregti, Inxhinieri Civile dhe Restaurim



CS 004 24.11.2014
CS 010 04.12.2018

EP130_2 Versiun 5
Efektive date: 16/11/2016

Numeri i certifikatës: 0138
Data e Certifikimit Fillëtar: 09/08/2018
Data e lëshimit: 06/12/2018
E vlefshme deri më: 08/08/2021
Numeri i Rishtimit: 1



European Quality & Safety Control (EQSC): Selisjuan Pasha, Pallati 70/1, Kat 1, Nr.1, 1016 Tiranë, Shqipëri | Tel: +355 4 222 7074, E-mail: info@eqsc-cert.com, www.eqsc-cert.com

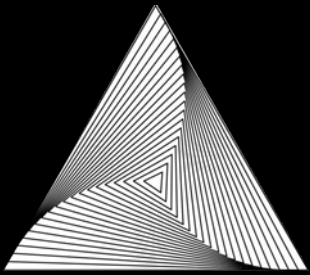

BACKGROUND TO

WORKING TOGETHER FOR BETTER TOMORROW

WORK LOCAL THINK GLOBAL

R&T GROUP

GLOBAL GROUP

BELLEK LOK JOCELHEK MOBKING

ЛИНІК ГОСУД МОВК

EQSC
European Quality & Safety Control

CERTIFIKATË

European Quality and Safety Control (EQSC)
lëshon këtë certifikatë për

R & T sh.p.k
Rr: Luigj Gurakuqi, P.89, Sh.A
1001 Tiranë, Shqipëri

R&T

Duke konfirmuar zhvillimin dhe zbatimin efektiv të
**SISTEMIT TË MENAXHIMIT TË SHËNDETTIT
DHE SIGURISË NË PUNË**

Në përputhje me kërkesat e Standardit Ndërkombëtar:
ISO 45001:2018

Për fushën e aktivitetit:
Tregti, Inzhinieri Civile dhe Restaurim

Accredited by
DA
CS 004 24.11.2014
CS 010 04.12.2018

EA: 28, 29

Numeri i certifikatës: 0194
Data e Certifikimit Fillëtar: 25/09/2019
Data e Rishikimit: 24/09/2022
E vlefshme deri më: N/A
Numeri i Rishikimit: N/A

09/170/2 - Tiranë, Shqipëri
European Quality & Safety Control (EQSC) Rr. Selçukun Paşa, Pallat 70/1, Kat 1, No 1, 1016 Tiranë, Shqipëri. Tel: +355 4 222 7074, E-mail: info@eqscert.com, www.eqscert.com

EQSC
European Quality & Safety Control

CERTIFIKATË

European Quality and Safety Control (EQSC)
lëshon këtë certifikatë për

R & T Sh.p.k.
Rr: Luigj Gurakuqi, P. 89, Sh. A
1001 Tiranë, Shqipëri

R&T

Duke konfirmuar zhvillimin dhe zbatimin efektiv të
SISTEMIT TË MENAXHIMIT TË ÇILËSISË

Në përputhje me kërkesat e standardit:
ISO 9001:2015

Për fushën e aktivitetit:
Tregti, Inzhinieri Civile dhe Restaurim

EA: 28, 29

Numeri i certifikatës: 0118
Data e Certifikimit Fillëtar: 09/08/2018
Data e Rishikimit: 08/12/2021
E vlefshme deri deri më: 08/08/2024
Numeri i Rishikimit: 1

09/170/2 - Tiranë, Shqipëri
European Quality & Safety Control (EQSC) Rr. Selçukun Paşa, Pallat 70/1, Kat 1, No 1, 1016 Tiranë, Shqipëri. Tel: +355 4 222 7074, E-mail: info@eqscert.com, www.eqscert.com

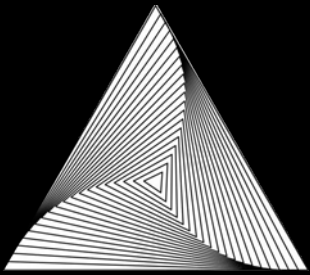

BACKGROUND TO

WORKING TOGETHER FOR BETTER TOMORROW

WORK LOCAL THINK GLOBAL

WORK LOCAL THINK GLOBAL

БЕЛЛЕК ЛОК ТОГЕЛНЕК МОККИК

ЛИИК ГОСУТ МОКК

R&T GROUP

GLOBAL

GLOBAL



EQSC
European Quality & Safety Control

CERTIFIKATË

European Quality and Safety Control (EQSC)
lëshon këtë certifikatë për

R & T Sh.p.k.
Rr: Luigj Gurakuqi, P. 89, Sh. A
1001 Tiranë, Shqipëri

R&T

Duke konfirmuar zhvillimin dhe zbatimin efektiv të
SISTEMIT TË MENAXHIMIT TË MJEDISIT

Në përputhje me kërkesat e standardit:
ISO 14001:2015

Për fushën e aktivitetit:
Tregti, Inxhinieri Civile dhe Restaurim

EAC 28, 29

Accredited by
DA
CS 004 24.11.2014
CS 010 06.12.2018
FID 2, Version 3
Effective Date: 16/11/2014

Numbri i certifikatës: 0134
Data e Certifikimit Fillëtar: 09/08/2018
Data e rishikimit: 06/12/2018
E vlefshme deri më: 08/08/2021
Numbri i Rishikimit: 1

European Quality & Safety Control (EQSC): Subjapan Park, Pallati 70/1, Kat 1, Nr 1, 1016 Tiranë, Shqipëri. Tel: +355 4 222 7674. E-mail: info@eqsc-cert.com, www.eqsc-cert.com

EQSC
European Quality & Safety Control

CERTIFIKATË

European Quality and Safety Control (EQSC)
lëshon këtë certifikatë për

R & T Sh.p.k.
Rr: Luigj Gurakuqi, P. 89, Sh. A
1001 Tiranë, Shqipëri

R&T

Duke konfirmuar zhvillimin dhe zbatimin efektiv të
SISTEMIT TË MENAXHIMIT TË SHËRBIMIT TË TEKNOLOGJISË SË INFORMACIONIT

Në përputhje me kërkesat e standardit:
ISO 20000-1:2011

Për fushën e aktivitetit:
Tregti, Inxhinieri Civile dhe Restaurim

Accredited by
DA
CS 004 24.11.2014
CS 010 06.12.2018
FID 2, Version 3
Effective Date: 16/11/2014

Numbri i certifikatës: 0136
Data e Certifikimit Fillëtar: 09/08/2018
Data e rishikimit: 06/12/2018
E vlefshme deri më: 08/08/2021
Numbri i Rishikimit: 1

European Quality & Safety Control (EQSC): Subjapan Park, Pallati 70/1, Kat 1, Nr 1, 1016 Tiranë, Shqipëri. Tel: +355 4 222 7674. E-mail: info@eqsc-cert.com, www.eqsc-cert.com



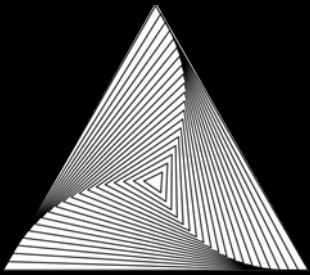

BACKGROUND TO

WORKING TOGETHER FOR BETTER TOMORROW

WORK LOCAL THINK GLOBAL

GLOBAL GROUP

R&T

WORKING TOGETHER FOR BETTER TOMORROW

BELLEK LOK JOCELHEK MOBKING

ЛИНК ГОСУТ МОБКИН



CERTIFIKATË

European Quality and Safety Control (EQSC)
lëshon këtë certifikatë për

R & T Sh.p.k.
Rr: Luigj Gurakuqi, P. 89, Sh. A
Tiranë, Shqipëri



Duke konfirmuar zhvillimin dhe zbatimin efektiv të
SISTEMIT TË MENAXHIMIT TË ENERJISË

Në përputhje me kërkesat e standardit:
ISO 50001:2011

Për fushën e aktivitetit: Tregti, Inxhinieri Civile dhe Restaurim

Ky dokument është lëshuar në bazë të Sistemit të Certifikimit të EQSC dhe Standartit përkatës.

Vlefshmëria e kësaj certifikate mbahet nëpërmjet auditimeve mbikëqërëse vjetore dhe auditimit të ri-certifikimit në çdo tre vjet.

EQSC rezervon të drejtën të tërheqë këtë certifikatë sipas kushteve të përcaktuara në Sistemin e tij të Certifikimit.

Akredituar nga



CS 004 24.11.2014
CS 010 04.12.2018

PR 001_2 Versiun 3
E lexuar dhe 04/11/2014

Numri i certifikatës: 0088
Data e Certifikimit Fillëtar: 12/03/2018
Data e lëshimit: 06/12/2018
E vlefshme deri më: 11/03/2021
Numri i Rishtimit: 1



European Quality & Safety Control (EQSC): Rr. Sulejman Pasha, Pallati 70/1, Kati 1, Nr. 1, 1016, Tiranë, Shqipëri | Tel: +355 4 222 7674, E-mail: info@eqsc-cert.com, www.eqsc-cert.com



CERTIFIKATË

European Quality and Safety Control (EQSC)
lëshon këtë certifikatë për

R & T Sh.p.k.
Rr: Luigj Gurakuqi, P. 89, Sh. A
1001 Tiranë, Shqipëri



Duke konfirmuar zhvillimin dhe zbatimin efektiv të
SISTEMIT TË INTEGRUAR TË MENAXHIMIT

Në përputhje me kërkesat e standardit:
PAS 99:2012

Sistemi i Integruar i Menaxhimit të Klientit është në përputhje me
**ISO 9001:2015; ISO 14001:2015; OHSAS 18001:2007; ISO 27001:2013;
ISO 39001:2012; ISO 50001:2011**

Për fushën e aktivitetit:
Tregti, Inxhinieri Civile dhe Restaurim
EAC: 28, 29

Ky dokument është lëshuar në bazë të Sistemit të Certifikimit të EQSC dhe Standartit përkatës.

Vlefshmëria e kësaj certifikate mbahet nëpërmjet auditimeve mbikëqërëse vjetore dhe auditimit të ri-certifikimit në çdo tre vjet.

EQSC rezervon të drejtën të tërheqë këtë certifikatë sipas kushteve të përcaktuara në Sistemin e tij të Certifikimit.

PR 001_2 Versiun 3
E lexuar dhe 04/11/2014

Numri i certifikatës: 0135
Data e Certifikimit Fillëtar: 09/08/2018
Data e lëshimit: 09/08/2018
E vlefshme deri më: 08/08/2021
Numri i Rishtimit: N/A



European Quality & Safety Control (EQSC): Rr. Sulejman Pasha, Pallati 70/1, Kati 1, Nr. 1, 1016, Tiranë, Shqipëri | Tel: +355 4 222 7674, E-mail: info@eqsc-cert.com, www.eqsc-cert.com

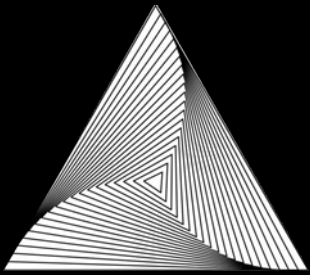

BACKGROUND TO

WORKING TOGETHER FOR BETTER
 WORK LOCAL THINK GLOBAL
 R & T GROUP

WORLDWIDE TOMORROW
 GLOBAL TODAY
 BELLEK LOK TOCELHEK MOBKING
 LHIHK TOSYT MOBK



CERTIFIKATË



R & T Sh.p.k

Rruga Luigj Gurakuqi, Pall. 89, Shk. A - Tirana - Albania
(J61901094G)

Kompania e lartecur është duke e zbatuar sistemin e menaxhimit sipas fushëveprimit dhe në përputhje me standardet relevante të aprovuara nga KingCert.

EN ISO 3834-2:2006

EN ISO 3834-2:2006 Kushtet e cilësisë për shkërbjen e metaleve (Kualifikimi në produktet e saldura)

Fushëveprimi : Tregtim, Inxhinieri civile dhe restaurime.

Kjo certifikatë është e vlefshme përderisa kompania e lartecur i përmbush kërkuesit e standardit EN ISO 3834-2:2006 dhe përmbush të gjitha përgjegjësit ndaj KingCert.

Dt. Publikimit të Cert : 16.09.2019
 Dt. Revizimit të Cert : 15.09.2021
 Dt. Përfundimit të Cert : 16.09.2022
 Numri i Certifikatës : A-160102

King Cert International Certification Ltd.
Director

King Cert International
Certification Ltd.
Manastri i Lirë, Str. Lirësi
Rr. 15, Shk. Buzdara
Tirana, Shqipëri
info@kingcert.com
FR.25 / 01.09.2016 / 04.08.2019 / 02

Мы рады, King Cert International Certification Ltd., в сотрудничестве с компанией логистический системы и менеджмент на профессиональном уровне и в соответствии с стандартом. Кож сертификат действителен для 2-х лет, если вы будете соблюдать все условия, которые указаны в сертификате. Проверка и сертификация услуг предоставляются по адресу: www.kingcert.com. Кож сертификат действителен в соответствии с стандартом King Cert International Certification Ltd., если вы будете соблюдать все условия в стандарте.



CERTIFIKATË



R & T Sh.p.k

Rruga Luigj Gurakuqi, Pall. 89, Shk. A - Tirana - Albania
(J61901094G)

Kompania e lartecur është duke e zbatuar sistemin e menaxhimit sipas fushëveprimit dhe në përputhje me standardet relevante të aprovuara nga KingCert.

SA 8000:2014

Certifikimi i Sistemit të Menaxhimit të Përgjegjëshmërisë Sociale

Fushëveprimi : Tregtim, Inxhinieri civile dhe restaurime.

Kjo certifikatë është e vlefshme përderisa kompania e lartecur i përmbush kërkuesit e standardit SA 8000:2014 dhe përmbush të gjitha përgjegjësit ndaj KingCert.

Dt. Publikimit të Cert : 21.01.2020
 Dt. Lehtësimit të Cert : 21.01.2021
 Dt. Përfundimit të Cert : 20.01.2022
 Numri i Certifikatës : KC17254

King Cert International Certification Ltd.
Director

King Cert International
Certification Ltd.
Manastri i Lirë, Str. Lirësi
Rr. 15, Shk. Buzdara
Tirana, Shqipëri
info@kingcert.com
FR.25 / 01.09.2016 / 04.08.2019 / 02

Мы рады, King Cert International Certification Ltd., в сотрудничестве с компанией логистический системы и менеджмент на профессиональном уровне и в соответствии с стандартом. Кож сертификат действителен для 2-х лет, если вы будете соблюдать все условия, которые указаны в сертификате. Проверка и сертификация услуг предоставляются по адресу: www.kingcert.com. Кож сертификат действителен в соответствии с стандартом King Cert International Certification Ltd., если вы будете соблюдать все условия в стандарте.



CERTIFICATE OF CONFORMITY FOR ROAD TRAFFIC SAFETY MANAGEMENT SYSTEM PER SISTEMIN E MENAXHIMIT TE SIGURISE NE TRAFIKUN RRUGOR

Certificate No / Nr i Certifikatës: AQS/RTS/65382021

Name of Company / Emri i Kompanisë: "R & T" SHPK
NIPT: 361901094G

Address/Adresa: Rruga Luigj Gurakuqi, Pallati 89, Shk.A, Kati 10, Tirana, Albania

Standard / Standarti: BS ISO 39001:2012

Concerning the following for services / Per fushar e aktiviteve si me poshte:

Management of the personnel and vehicles logistic for the activity of:
Civil construction, restorations, Trade and transport of construction vehicles.

Menaxhimi i logjistikes si personelit dhe mjeteve te transportit per aktivite te Ndertime civile, restaurime ,Tregeti dhe transport i autombjeteve te ndertimit.

Validity of the Certificate / Vlefshmeria e Certifikates:

First Issue/Emision i parë	The first maintenance within	The second maintenance within	Expiry Date e fundit
24/02/2021	24/02/2022	24/02/2023	23/02/2024

The validity of this certificate is based on the conditions stipulated in the AQSCERT Regulation. The validity of the certificate is subject to annual maintenance and a complete re-assessment at 2 year intervals. To check the validity of the certificate and the status of the certificate holder, please visit the website www.kingcert.com or contact the nearest King Cert office.



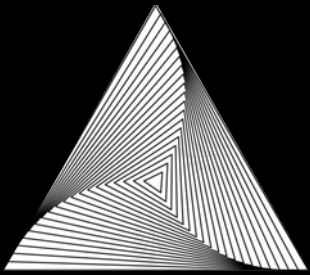

GROUP OPERATIONS

WORKING TOGETHER FOR BETTER
WORK LOCAL THINK GLOBAL
R&T GROUP

ВОРОМОТ ЗАВТРА
РАБОТАЙТЕ МЕСТНО
ДУМАЙТЕ ГЛОБАЛЬНО
R&T ГРУППА



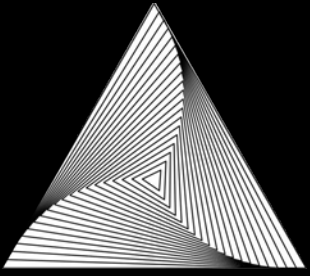

OUR 'QUALITY' COMMITMENT

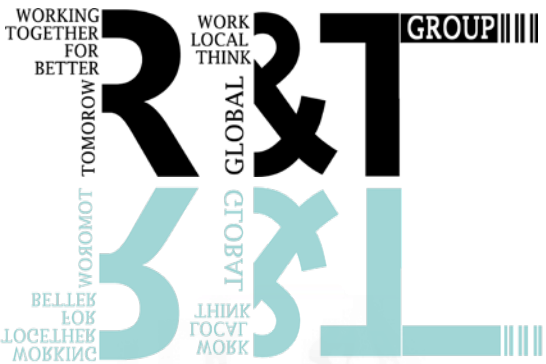

- ISO Standards
- We conduct open and candid discussions at all levels
- We operate in an open and transparent manner
- Internal quality control
- All members of staff are High Qualified
- Any member of staff can manage a project
- We adhere to strict Health and Safety guidelines
- Site security for people, materials and protection of our client assets

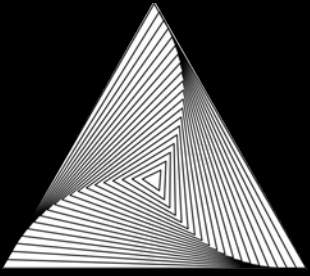

OUR 'QUALITY' COMMITMENT

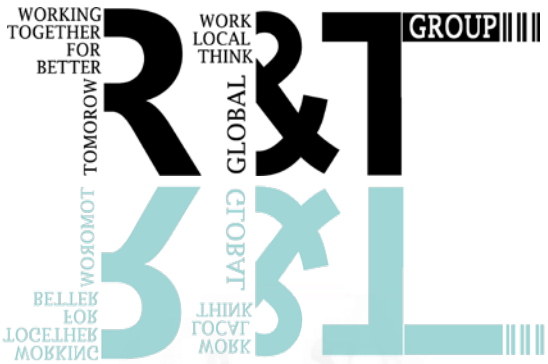

WE OFFER FULL WARRANTED AND CERTIFIED QUALITY ASSURANCE SYSTEM IN:

- **CIVIL ENGINEERING & RESTORATION**
- **DESIGN & IMPLEMENTATION**
- **TESTING & COMMISIONING**
- **SUPERVISION**

- **PROJECT MANAGEMENT**

- **COST MANAGEMENT**
- **SCHEDULE MANAGEMENT**
- **QUALITY MANAGEMENT**
- **PROCUREMENT**
- **COORDINATION**

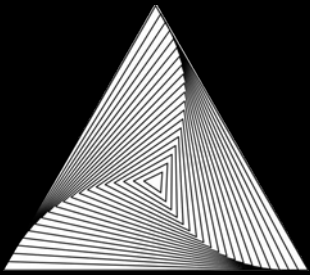

CIVIL ENGINEERING - FIELD OF

Excavation Works

Civil & Industrial construction

Reconstruction & Maintenance

Streets, highways, railroads, subways, airport tracks

Water supply systems

Sub Stations, cabins and transformer lines, H&M voltage transmission lines, energy distribution

Lifting & Transportation plants

Hydro-sanitary plants, kitchen, laundry, their maintenance

WORKING TOGETHER FOR BETTER TOMORROW

WORK LOCAL THINK GLOBAL

R & T GROUP

BELEK FOR LOCALNEB MOBKIC

ИНИК ГОСУТ МОБК

REPUBLICA E SHQIPËRISË
MINISTRIA E KULTURËS
Keshilli Kombëtar i Trashëgimisë Kulturore Materiale

LICENCË
SH. Z. 10

SHOQËRIA: "R&T" SHPK
DREJTUES LIGJOR: RENIS TERSHANA
DREJTUES TEKNIK: VELI SHEHU (Z.A.26)
ADRESA: TIRANË

Regjistruar në regjistrin themeltar Nr. 9 Urdhër Nr. 208 që nga data: 31.03.2021

NË ZBATIM

N-Z/A/2 Zbatim në konservim dhe restaurim i ndërtimeve me karakter mbrojtës

N-Z/A/3 Zbatim në konservim dhe restaurim i arkitekturës së kultit

N-Z/A/4 Zbatim në konservim dhe restaurim i ndërtimeve inxhinierike

N-Z/A/5 Zbatim në konservim dhe restaurim i arkitekturës së traditës (vernakulare)

N-Z/A/6 Zbatim në konservim dhe restaurim i arkitekturës së projektuar

N-Z/A/7 Zbatim në konservim, restaurim dhe rikualifikim i hapësirave (rrugë, sheshë) brenda qendrave historike dhe ansambleve historike urbane

MINISTRI I KULTURËS
ELVA MARGARIT

Shënim: Kjo licencë është e vlefshme deri në Pa afat

000244

REPUBLICA E SHQIPËRISË
MINISTRIA E INFRASTRUKTURËS DHE ENERJISË
Komisioni i Pozaçim i Dhënies së Licensave Profesionale për Shoqëritë që Ushtrjnë Veprimtari Ndërtuese Zbatimi

LICENCE
NZ.4490/15

SHOQËRIA: "R & T"
DREJTUES LIGJOR: RENIS TERSHANA
DREJTUES TEKNIK: KOZËTA NIKA, VELI SHEHU, ELVIS NESHJA, INELDA MECI, SASHENKA AVRAMI, EDMOND GJACI, ISUF BORICI, EDMOND CEKA, ELMAZ QALLIMI, KUJTIM ONUZI, ANASTAS DONA
REZIDENCA: TIRANË

Regjistruar në Regjistrin themeltar që nga data: 26.10.2020

Kategori	Klasifikim	Emërtimi i kategorisë
NP-1	D	Punime gërmimi në tokë
NP-2	G	Ndërtime civile dhe industriale
NP-3	F	Rikonstruksion dhe rimbërtitje godinash civile e industriale, vesheje fasada
NP-4	E	Rrugë, autostrada, mbikallime, hekurudra, trenovë, metro, pista aeroportuale
NP-5	D	Punime ndërtimore, ura e vepra arti
NP-6	A	Diga dhe tuneli hidroteknike
NP-7	C	Ujësjellës, gazsjellës, vësjellës, vepra kulturi e vadije
NP-8	A	Ndërtime detare dhe punime thellimi në ujë
NP-9	D	Punime dhe mbrojtje lumore sisteme hidraulike dhe borifikime
NP-10	A	Ndërtimi i impianteve për prodhimin e energjisë elektrike
NP-11	G	Ndërtimi për Njësitacion, kabinet e transformatorive linja e TN e të mesëm dhe shpërndarjen e energjisë
NP-12	C	Punime të mhartësisë së mjedistit
NS-1	B	Punime për prapitjen e ndërtimeve
NS-2	B	Impiante hidro-sanitare, luzhina, lavantieri, marimbajtja e tyre
NS-3	A	Impiante rregjise dhe transportues (zashonori, shkalë levizëse, transportues)
NS-4	E	Punime rindërtim të muraturës dhe të lidhura me to, rindërtim me materiale druri, plastik, metalik dhe zhanra dhe rindërtim të ndërtimit të ndërtimit
NS-5	B	Impiante të sigurtësisë ndërtimit të trafikut
NS-6	A	Simplifikim rrugore jo ndërtimore
NS-7	C	Barriera dhe mbrojtje rrugore
NS-8	F	Ndërtimi parafabrikat beton arme, struktura metalike dhe druri
NS-9	D	Punime strukturorë speciale
NS-10	A	Shëtitore dhe infrastruktura speciale
NS-11	A	Punime mbi shina dhe traversa
NS-12	C	Impiante telekologjike, termike dhe të kondicionimit
NS-13	E	Impiante dhe linja telefonike dhe telekomunikacioni
NS-14	E	Impiante të ndërtesave, ofisore, shkollore, radiofonore TV etj.
NS-15	B	Pastrimi i ujërave detare, liqenori dhe lumori
NS-16	A	Ndërtimi i impianteve të ujit të pijshëm dhe pastrimit të tij
NS-17	A	Ndërtimi i impianteve të grumbullimit dhe trajtimit të mbetjeve urbane
NS-18	B	Punime topogjeodezike
NS-19	B	Sisteme kundër zhmëritës për infrastruktura
NS-20	B	Shpime gjeologjiko-inxhinierike, zuse e shpime për ujë

KRYETAR KOMISIONI
GERTA LUBONJA

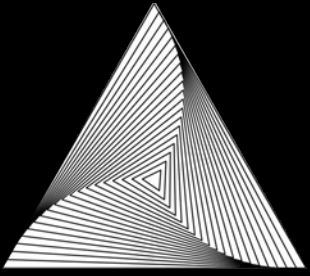

CIVIL ENGINEERING - FIELD OF ACTIVITY

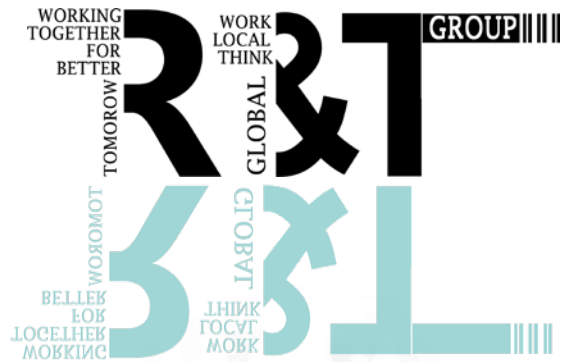

Roads signalization

Road barriers and protection

Prefabricated construction,
reinforced concrete, metallic &
wood structures

HVAC

Telecommunications &
Telephony

Restoration Works

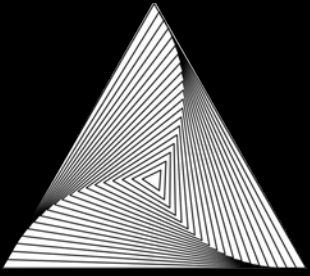

OVERVIEW OF R&T GROUP TECHNICAL CAPACITY

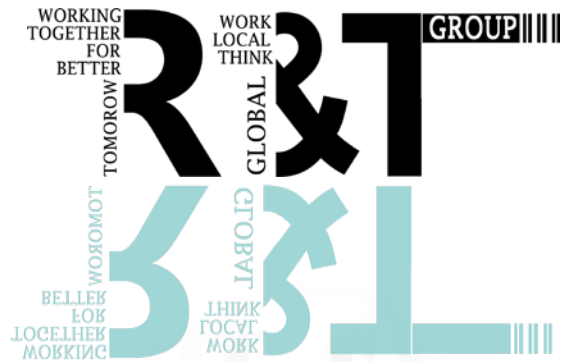

- VEHICLES AND TRUCKS
- LOADERS
- EXCAVATORS
- CONCRETE MIXERS
- CONCRETE VIBRATORS
- WATER TANKS
- GENERATORS
- ELECTRICAL TOOLS
- OTHER TOOLS
- TELECOMMUNICATION TOOLS
- Puller & tensioner
- FO Tool kit
- Splicer
- Blowing Machine

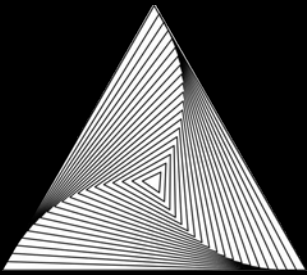

FINANCIALS



WORKING TOGETHER FOR BETTER
TOMORROW
BETTER FOR TOMORROW
R&T GROUP
WORK LOCAL THINK GLOBAL
GLOBAL
ЛУЧШЕ ВМЕСТЕ
ДУМКАЙТЕ МЕСТНО
МЫСЛИТЕ ГЛОБАЛЬНО
ЛУЧШЕ ЗАВТРА
ЗАВТРА

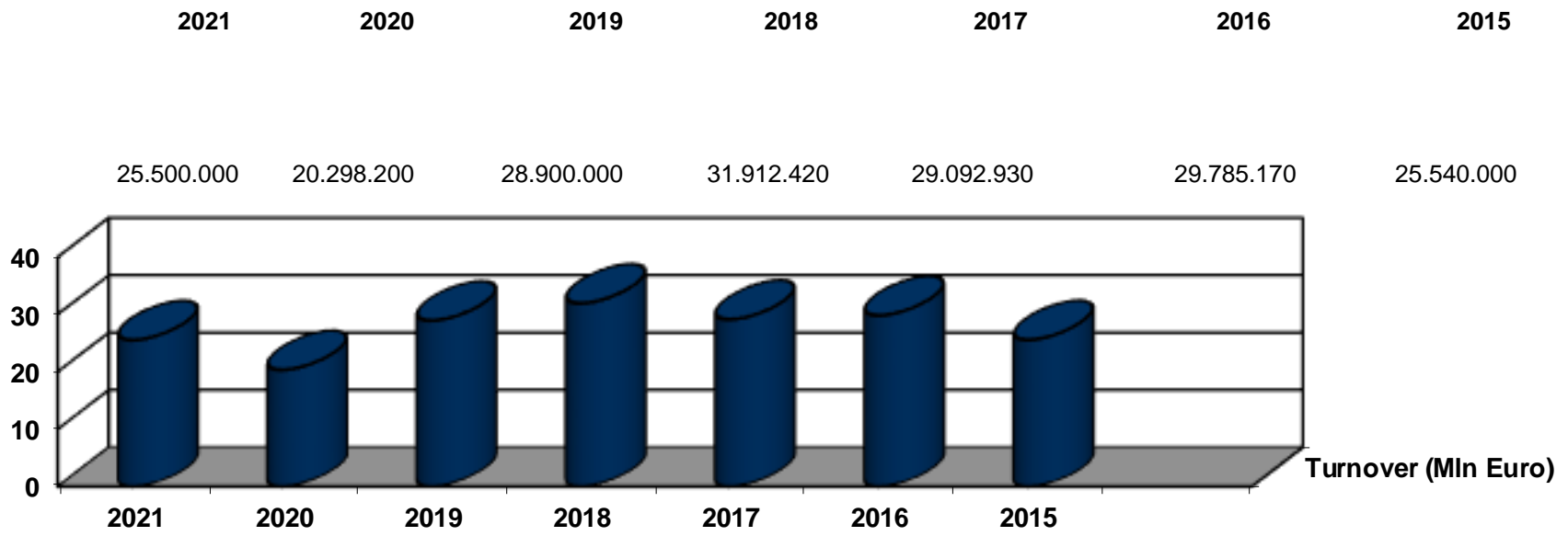

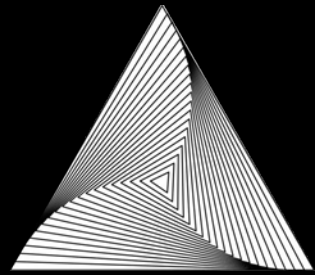

RAMS

Supply and installation of a Road Asset Management System (RAMS) in Albania

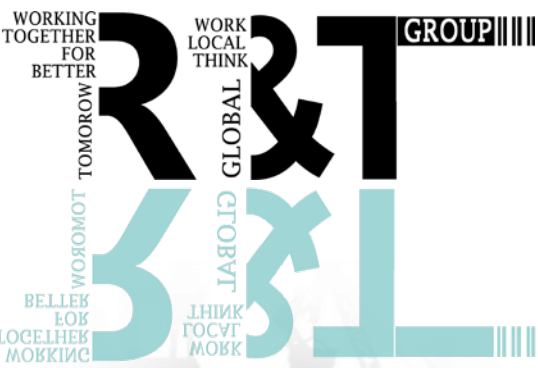

- HW supply and installation (Rack, servers, storage systems, NAS, UPS, workstations, printers, etc.)
- SW supply and installation
- Supply and installation of network equipment
- Supply, installation and customization of HDM-4 software
- Development of Spatial Database
- Web GIS programming and processing
- RMS Development system
- BMS
- Training
- Management

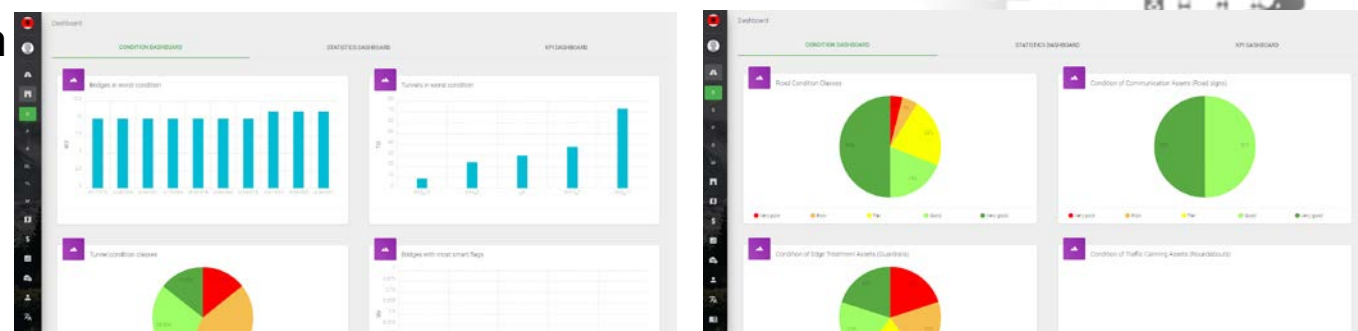
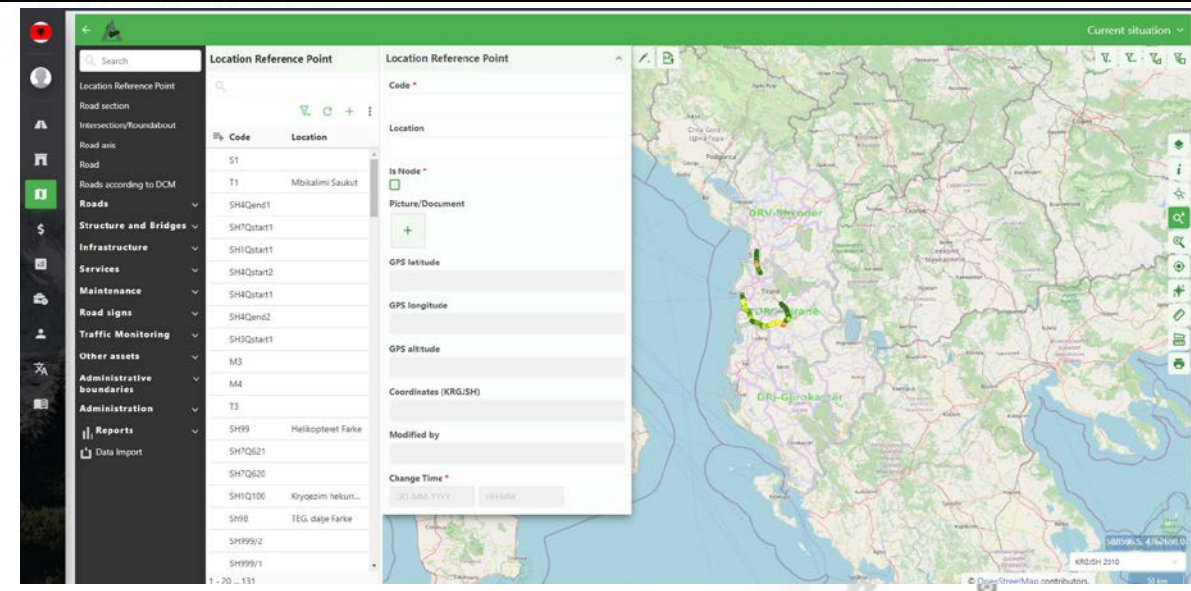

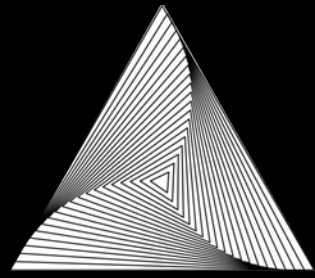

ELECTRONIC SYSTEM

Electronic System for management of visits and entry-exits in IEVP (Institution of Execution of Criminal Decisions) – for the Ministry of Justice



- Electronic system
- Software Development
- Supply and installation of servers, switches, fingerprint readers, workstations, scanners, UPS, printers, etc.
- Installation, configuration
- Training
- Maintenance

Task title	Project	Assigned to	Schedule Planned Hours	Remaining Hours	Stage	Progress
Multi-Users tested by the customer	Data Import/Export Plugin	Administrator	8,000	88,000 In-Progress		0%
User Interface design	E-Learning Integration	Administrator	19,000	19,000 Done		100%
Integrate Modules	Website for Sales & WMS	Administrator	24,000	24,000 In-Progress		0%
Internal testing - Software build	Website for Sales & WMS	Administrator	19,000	19,000 In-Progress		0%
Document history management	Research & Development	Senior User	13,000	13,000 In-Progress		0%
Social network integration	Research & Development	Senior User	88,000	88,000 In-Progress		0%
Design User Exams	E-Learning Integration	Senior User	12,000	12,000 Cancelled		100%
Improve Clean Code and Functionality	Research & Development	Administrator	40,000	40,000 In-Progress		0%
User Interface Improvements	Research & Development	Administrator	19,000	19,000 In-Progress		0%
Database Design	E-Learning Integration	Administrator	12,000	12,000 In-Progress		0%
User Acceptance Test	E-Learning Integration	Senior User	80,000	80,000 Cancelled		100%
Deploy and maintain test system	E-Learning Integration	Administrator	19,000	19,000 Done		100%
Integration of user management	E-Learning Integration	Senior User	14,000	14,000 In-Progress		0%
Customer analysis - architecture	Data Import/Export Plugin	Administrator	12,000	12,000 Cancelled		100%
Data Export flow	Data Import/Export Plugin	Administrator	19,000	19,000 In-Progress		0%
Project development document	Website for Sales & WMS	Senior User	40,000	40,000 In-Progress		0%
Budget Planning	Website for Sales & WMS	Administrator	19,000	19,000 Done		100%
Make UAT	Website for Sales & WMS	Senior User	21,000	21,000 In-Progress		0%
Develop Module for Sales Management	Website for Sales & WMS	Senior User	40,000	40,000 In-Progress		0%
Develop Module for Warehouse	Website for Sales & WMS	Administrator	19,000	19,000 In-Progress		0%

Project	Tasks	Overview	Forecast
Data Import/Export Plugin	Costing Account For Cycle of Assembly	Costing Account For Hours of Assembly	E-Learning Integration
Website for Sales & WMS	Website Design Templates		

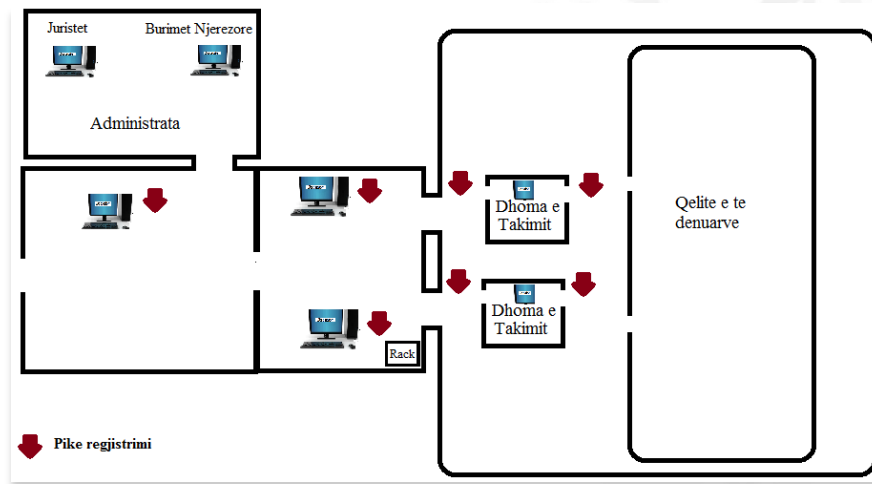

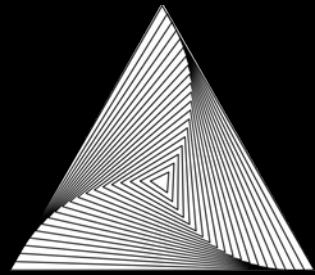

MONITORING SYSTEM

Implementation of surveillance system for protection and physical security of HPP and KESH sh.a and collection of images in the KESH sh.a. Dispatch Center

WORKING TOGETHER FOR BETTER
WORK LOCAL THINK GLOBAL
R&T GROUP

GLOBAL
ГЛОБАЛ

ВЕРИТЕ СЪВМЕСТНО
ВЕРИТЕ СЪВМЕСТНО

ВЕРИТЕ СЪВМЕСТНО
ВЕРИТЕ СЪВМЕСТНО

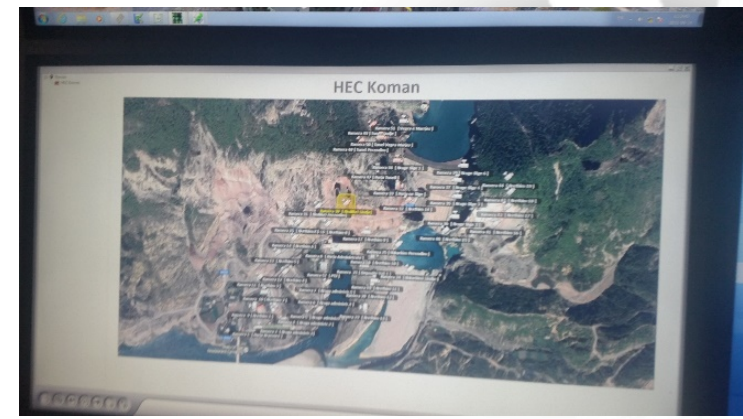

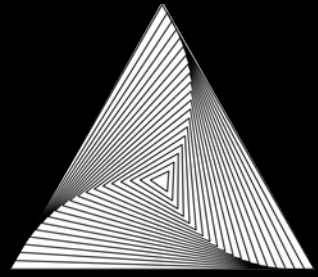

ACCESS CONTROL SYSTEM

Installation of Access Control System in ACC/TWR and integration with the “Rostering System”, in Albcontrol sh.a.

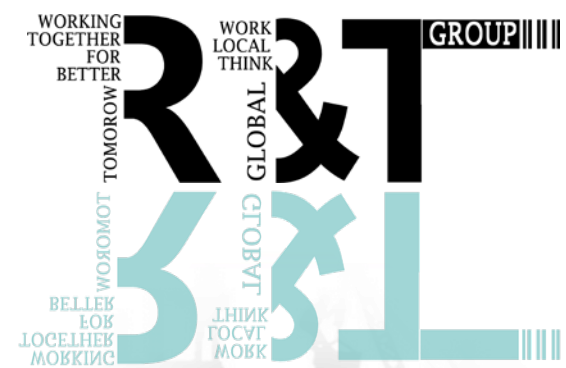

➤ Supply and installation of:

- Door controller
- Entry and Exit reader (Bio & Proximity)
- Road barriers
- LPR Camera
- Fix cameras
- Flap doors
- Perimeter control
- HW & SW for system implementation

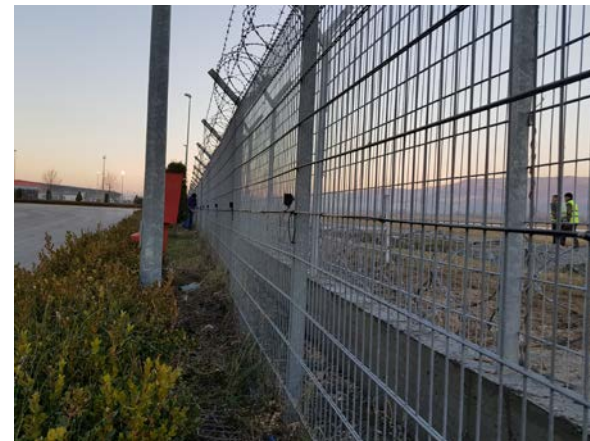

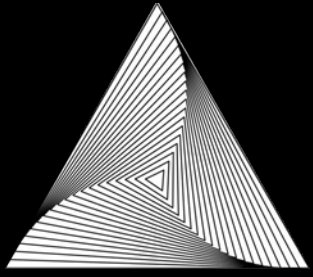

EVACUATION SYSTEM

VOICE EVACUATION SYSTEM AND PUBLIC MESSAGES (VAS)

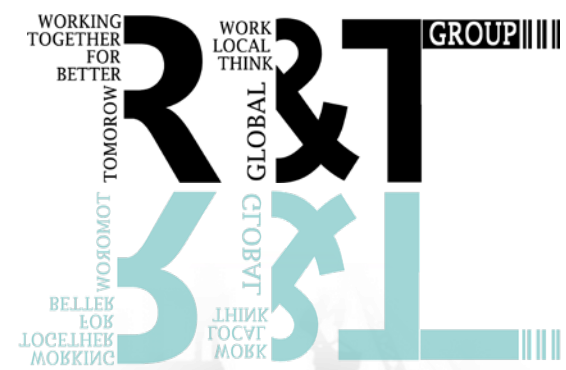

➤ Supply and installation of:

- Exit digital module
- Amplifiers
- Microphone
- Commutation unit
- Loudspeaker
- Civil works
- HW & SW for system implementation

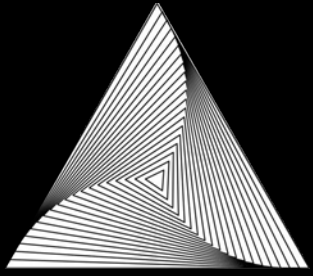

ALARM SYSTEM

Construction of alarm system in the dams of Drin river cascade

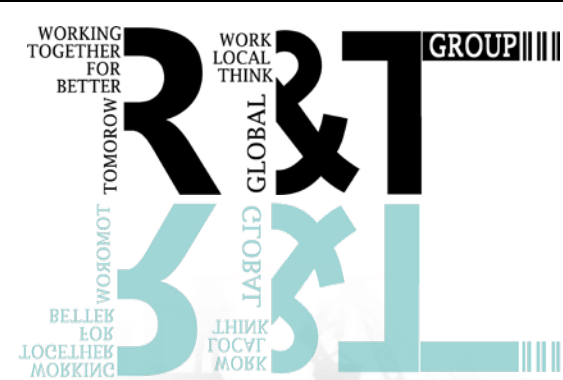

- Basement for the stations
- Security enclosure for the stations
- Tower for the sirens
- Command panel
- Sirens with 360 degree horizontal coverage
- Microphone
- Radio
- Supply and installation of HW and SW

